

WORLD MARKET®

Assembly Instructions

BONAIRE STATIONARY EGG CHAIR

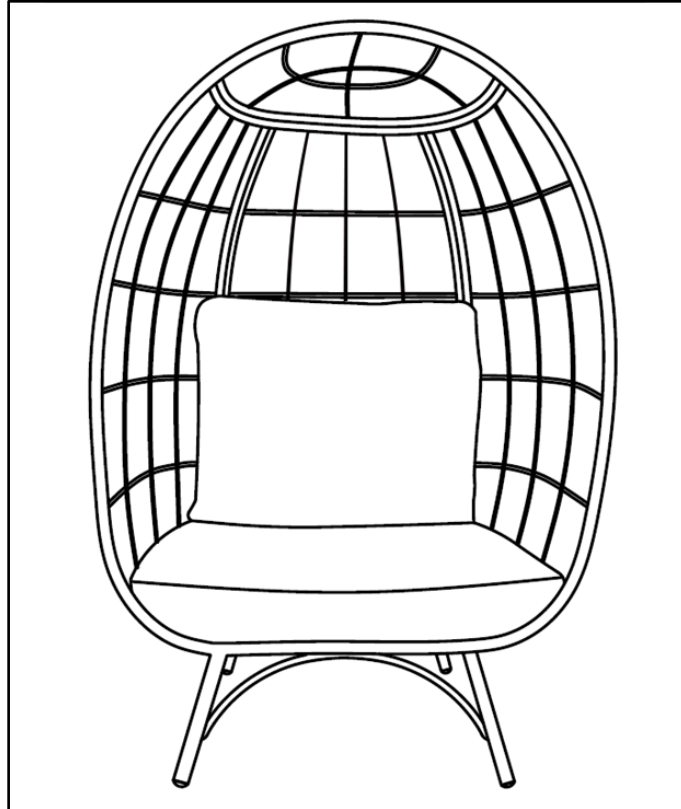





SKU- 619695



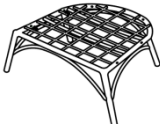

THANK YOU FOR YOUR PURCHASE. IF YOU HAVE ANY QUESTIONS
PERTAINING TO THE ASSEMBLY OF THIS FURNITURE PIECE, PLEASE CONTACT
THE NEAREST WORLD MARKET STORE.
IF YOU ARE NOT NEAR A STORE, PLEASE CALL OUR CUSTOMER SERVICE
CALL CENTER TOLL FREE AT 877-967-5362 FOR ASSISTANCE.

ALL PRODUCTS SOLD AT WORLD MARKET ARE NOT FOR
COMMERCIAL USE AND ARE INTENDED FOR RESIDENTIAL USE ONLY

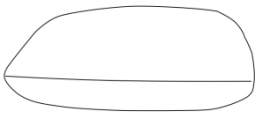
Component List

Label	Picture	Description	Qty
A		Base	1
B		Left Panel	1
C		Middle Panel	1
D		Right Panel	1
E		Top	1
F		Back Cushion	1
G		Seat Cushion	1

Hardware List

Label	Picture	Description	Qty
H-1	 M6 × 35mm	Bolt	10
H-2	 M6 × 20mm	Nut	10

H-3		Flat Washer	20
H-4		Clip	4



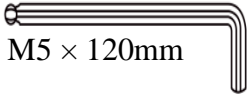
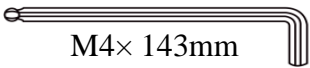

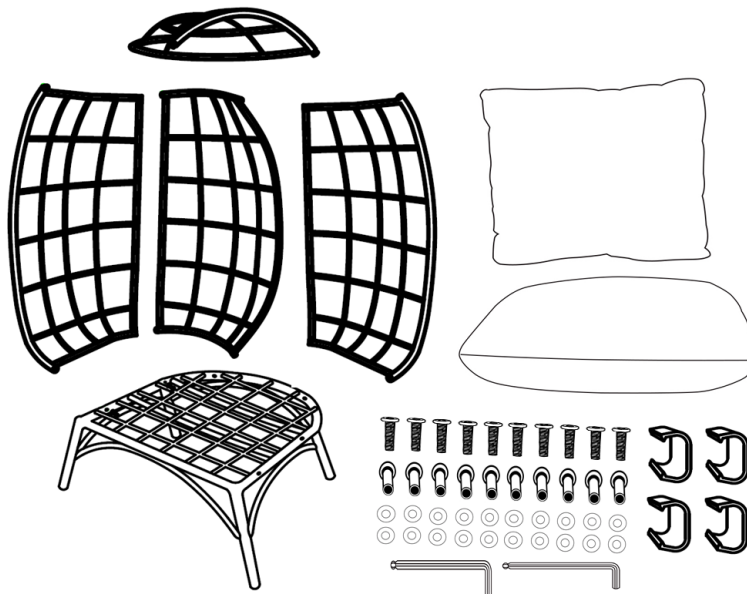

Tool List

Label	Picture	Description	Qty
T-1	 M5 × 120mm	Allen Key	1
T-2	 M4 × 143mm	Allen Key	1

Assembly Preparation

Before Beginning:



-  • . Unpack all hardware bags and components to ensure you have all parts-
-  • . Read instructions, cover to cover-
-  • . Have 2 adults on hand for assembly-
-  • . Do not assemble on flooring or carpet-
-  • . Assemble on a clean non-marring surface (packing foam)-
-  • . Save all packaging until finished-
-  • . In case of missing parts, please contact your nearest World Market store or call our customer call service center at 1-877-967-5362.

Assembly Steps

Step 1

 H-1 Bolt x 2

 H-2 Nut x 2

 H-3 Flat Washer x 4

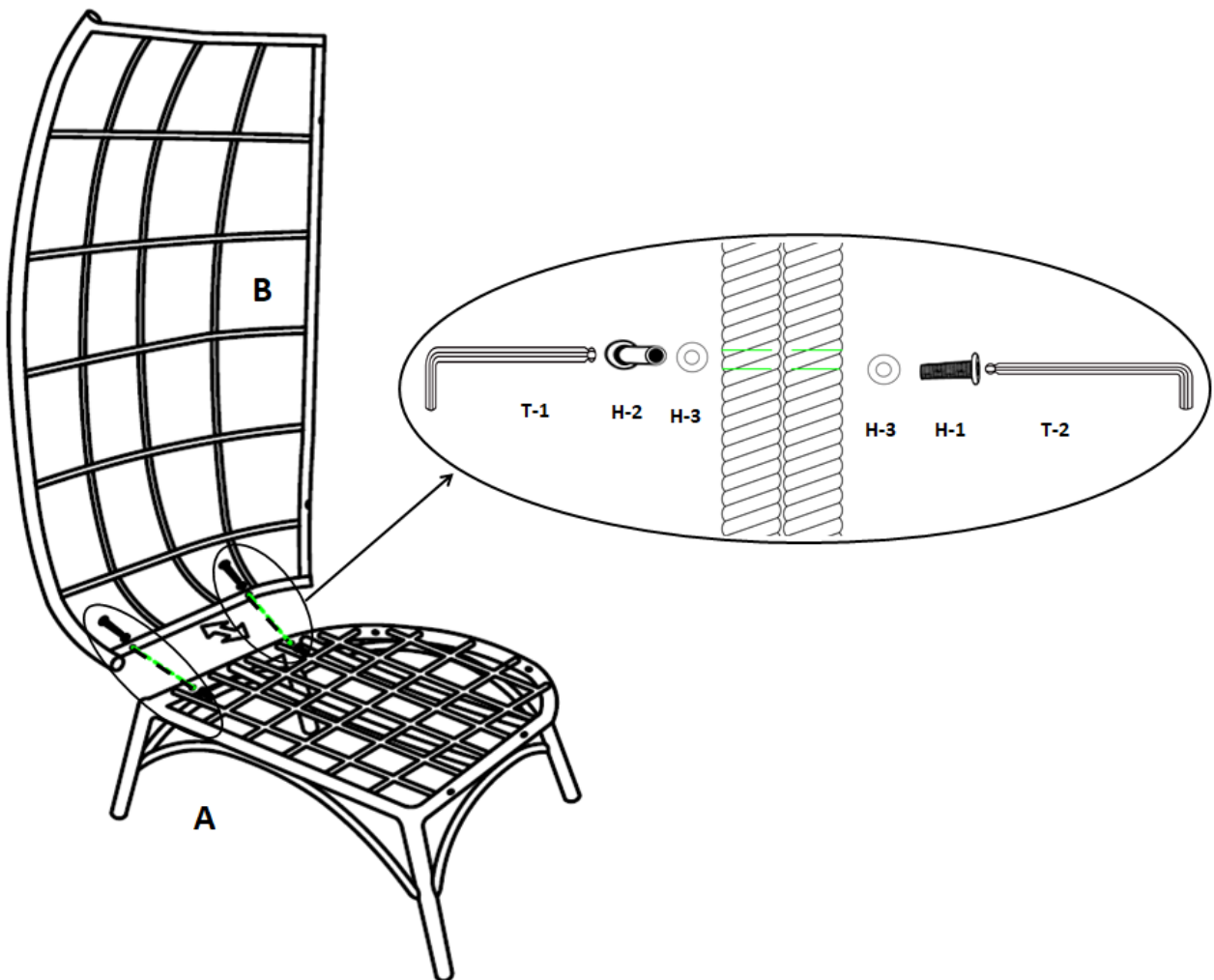

- It is recommended to have another person on hand to help with assembly. Carefully place Base (A) with the top facing up onto a padded, non-marring surface. Position Left Panel (B) to Base (A) so that both bolt holes are aligned. While one person holds Left Panel (B), secure 2 mounting points with Bolts (H-1), Nuts (H-2) and Flat Washers (H-3), stacking the hardware in the order as shown. Engage all Bolts first then gently tighten with provided Allen Keys (T-1) & (T-2).
Note: Do not fully tighten bolts until the entire frame is assembled.

Step 2

 H-1 Bolt x 4

 H-2 Nut x 4

 H-3 Flat Washer x 8

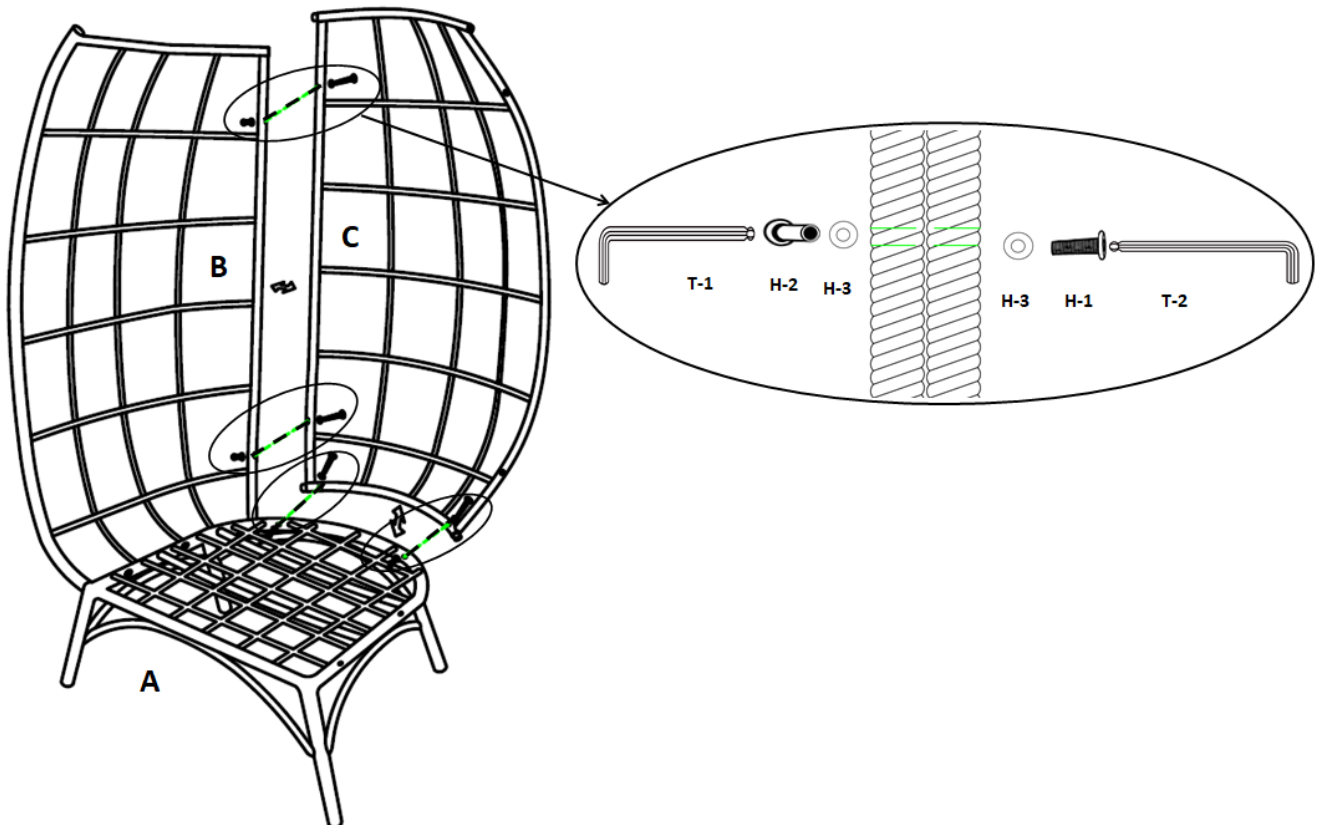

Using a second person to assist you, carefully position Middle Panel (C) to Base (A) and Left Panel (B) so that all bolt holes are aligned. While one person holds Middle Panel (C), secure all mounting points with Bolts (H-1), Nuts (H-2) and Flat Washers (H-3), stacking the hardware in the order as shown. Engage all Bolts first then gently tighten with provided Allen Keys (T-1) & (T-2).

Note: Do not fully tighten bolts until the entire frame is assembled.

Step 3

 H-1 Bolt x 4

 H-2 Nut x 4

 H-3 Flat Washer x 8

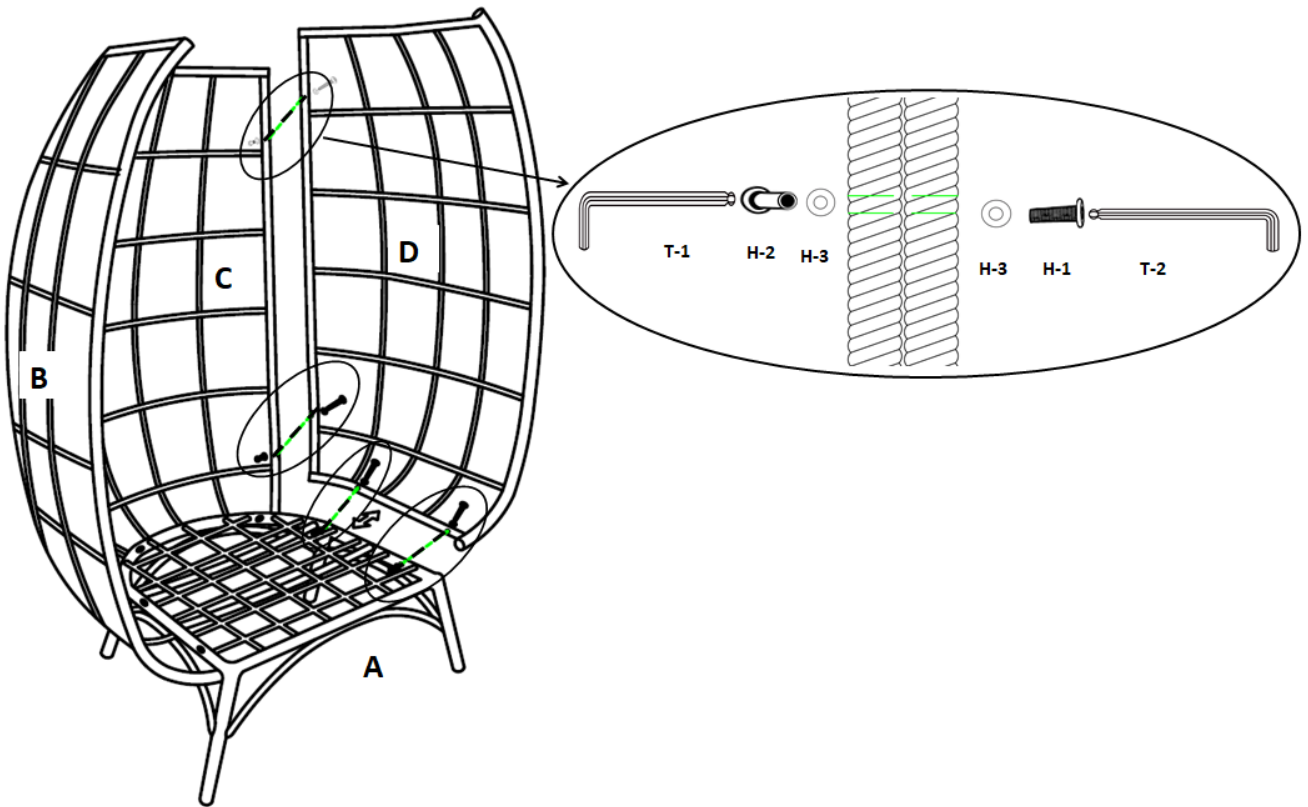

Using a second person to assist you, carefully position Right Panel (D) to Base (A) and Middle Panel (C) so that all bolt holes are aligned. While one person holds Right Panel (D), secure all mounting points with Bolts (H-1), Nuts (H-2) and Flat Washers (H-3), stacking the hardware in the order as shown. Engage all Bolts first then gently tighten with provided Allen Keys (T-1) & (T-2).

Note: Do not fully tighten bolts until the entire frame is assembled.

Step 4



H-4 Clip x

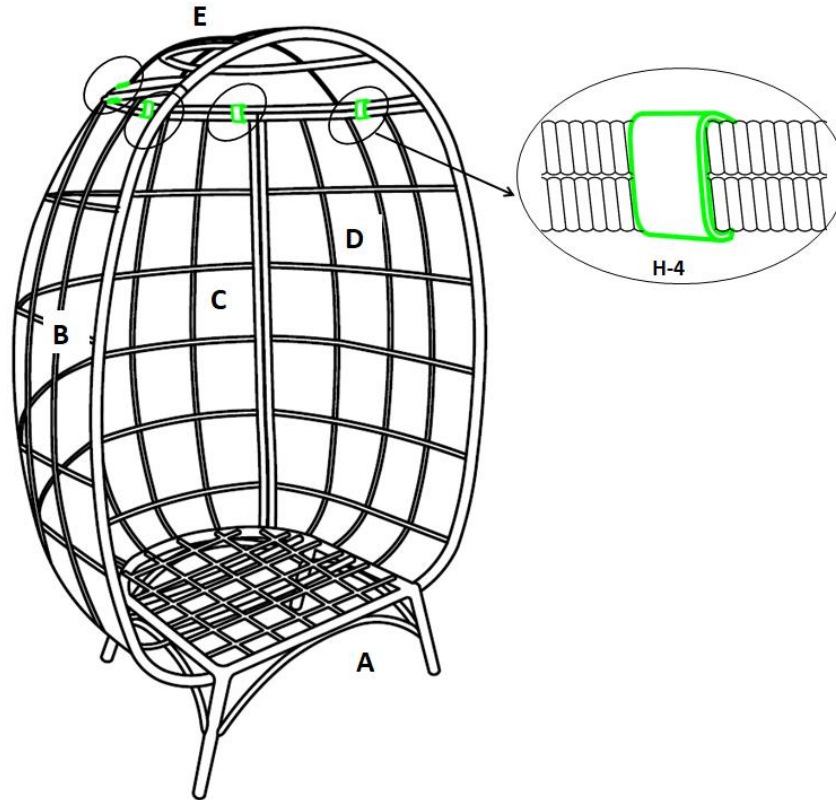

Attach Top (E) to all three Panels (B/C/D) by placing 4 clips around both frame tubes from the INSIDE of the assembly. Be sure to not damage any of the cross weaving while placing the clips. Position of the clips may vary. It is best to have two clips toward the front of the frame, and two toward the back. Fully tighten all hardware from previous steps with Allen Keys (T-1) & (T-2).

Step 5

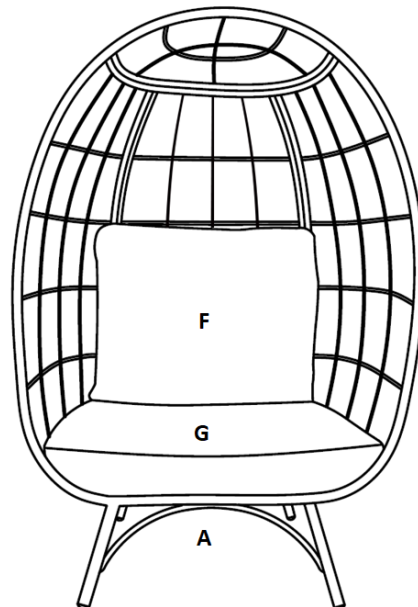

Put the Back Cushion (F) and Seat Cushion (G) onto the Base (A). Assembly is now complete and the product is ready for use.

Note: Cushions are directional. Ensure they are oriented correctly.

CHECK EVERY 3-4 MONTHS THAT ALLEN BOLTS SECURING SEAT TO BASE REMAIN FULLY TIGHTENED TO ENSURE STABILITY.

Care & Maintenance



• Do not put hot items directly on furniture surface.



• Do not clean furniture with harsh cleansers or polish.



• Do not place furniture near heating or cooling vents.



• Do not write on furniture without a padded barrier to protect the surface.



• All products sold at World Market are not for commercial use and are intended for residential use only.



• Store furniture and cushions or use an appropriate outdoor furniture cover during cold or inclement weather.



• Dust and pick up spills using a clean, non-colored, lint-free cloth.



• Stains may be removed with mild soap solution and damp cloth.

WORLD MARKET LIMITED ONE-YEAR WARRANTY – Outdoor Furniture

For your customer satisfaction, this product carries a LIMITED ONE-YEAR WARRANTY from the date of purchase. This limited warranty only applies to World Market brand furniture, and not to other furniture brands sold on World Market's website.

Where applicable, the limited warranty provides coverage for:

1. **Manufacturing, Material and Workmanship Defects:** Includes defects related to core frame/structure substrates (wood, metal and stone/tile); complete breakage of hardwood; cracking, splitting or lifting of wood veneer or laminated top surfaces caused by process failure; broken welds or improperly coated metal frame components (powder coating or painted); outdoor fabric, nautical rope and woven Textilene® defects including tears, misprints, fraying, crease marks, skip stitches or open seams; synthetic resin wicker breakage or unraveling; and other component failures that are a direct result of manufacturing or workmanship defects.
2. **Cushions:** Loss of resiliency from a material breakdown of foam or fiber filling, which should not be confused with softening or settling during normal use.
3. **Outdoor Furniture Components (Hardware & Mechanisms):** Includes defects to pre-installed components or hardware provided to the customer for assembly such as metal bases, swivel plate mechanisms; for umbrellas, canopy crank mechanism, spring loaded pole pins (for adjusting height); and other components such as bent or stripped threaded leg posts and adjustable levelers. Coverage also includes protection against rust and corrosion on hardware. For missing, damaged, corroded, or misplaced hardware components such as bolts or washers, please contact Customer Service at: 877-967-5362.

This LIMITED ONE-YEAR WARRANTY does NOT cover:

1. Damage due to mishandling during transportation from store or transportation without original protective packaging.
2. Abuse, negligence (product misuse), improper storage, stacking or wear and tear that may result in or from:
 - a. **Wood & Veneer:** Mishandling, prolonged exposure to moisture, peeling or discoloration caused by exposure to moisture or excessive sunlight, heat; splintered, dented or nicked panels, legs or component edges or paint/finish blemishes; or treatment with corrosive chemicals (dyes, inks, paints or harsh cleaning products). **NOTE: As with any outdoor rated wood, the color may fade if left in direct sunlight of inclement weather. Minor cracking may occur with age. These are naturally occurring features of wood and do not affect product performance.**
 - b. **Fabric (Including Sunbrella® Fabrics), Rope, Textilene®, All-Weather Wicker:** cuts, punctures, tears, burns, pet damage, or treatment with corrosive chemicals (dyes, inks, paints or harsh cleaning products), exposure to fire, high heat, water, or prolonged exposure to direct sunlight that may cause splitting, peeling, fraying or discoloration with time.
 - c. **Foam (Cushions):** Flattening, relaxing or settling/softening of foam components that comes with normal use.
 - d. **Hardware Components:** improper installation or misuse/substitution of hardware components not defined in the Assembly Instructions for the product (if applicable)
3. Damage due to prolonged environmental/inclement weather exposure such as direct sunlight, extreme heat, water or extreme humidity, strong winds, any bright light source (natural or artificial), chlorine or saltwater pools, or any environment that the product is not intended for. We HIGHLY recommend storing furniture, umbrellas and cushions with outdoor rated furniture covers and out of direct exposure during the winter or inclement weather events.
4. This warranty is applicable for outdoor furniture products purchased for residential use only.

For additional information on returns, please visit: <https://www.worldmarket.com/category/customer-service/returns.do>

All products sold at World Market are NOT FOR COMMERCIAL USE and are intended for residential use only. Products purchased for commercial use will VOID all warranty provisions as listed above.

Any claims under this LIMITED ONE-YEAR WARRANTY are valid and applicable only as to the original purchaser and must be accompanied by proof of purchase. Warranty claims should be submitted to a World Market store or through World Market Customer Service Call Center, Toll Free at 877-967-5362.

For valid warranty claims, World Market will repair or replace the product, or offer a full or partial credit, in the sole discretion of World Market. This LIMITED ONE-YEAR WARRANTY gives you specific legal rights and you may also have other rights which vary from state to state.

(OUTDOOR FURNITURE 1LW_v1.3_051122)